

SUPPORT[®]

E Series

Custom Tariff Code
3926.90.97.90.18

Pedestals Adjustable
from 35mm-1090 mm

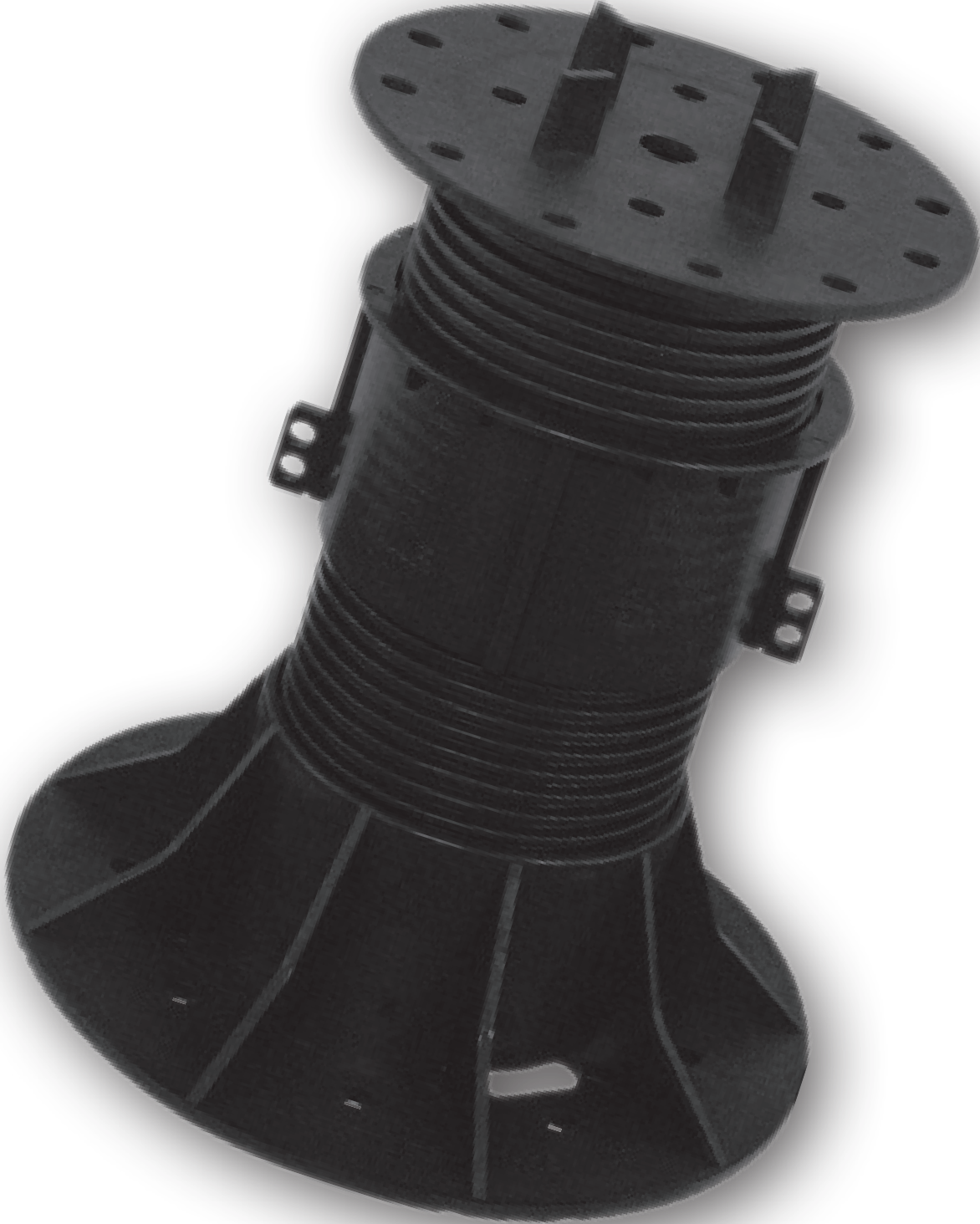

ST İthalat İhracat Ltd. Şti

Address: Yenibosna Doğu Sanayi Sitesi
2/11 34180 Bahçelievler - İstanbul / Turkey

T. +90 (212) 452 20 60
F. +90 (212) 452 20 27

E-mail : export@supportsystem.com
Web: www.supportpedestal.com

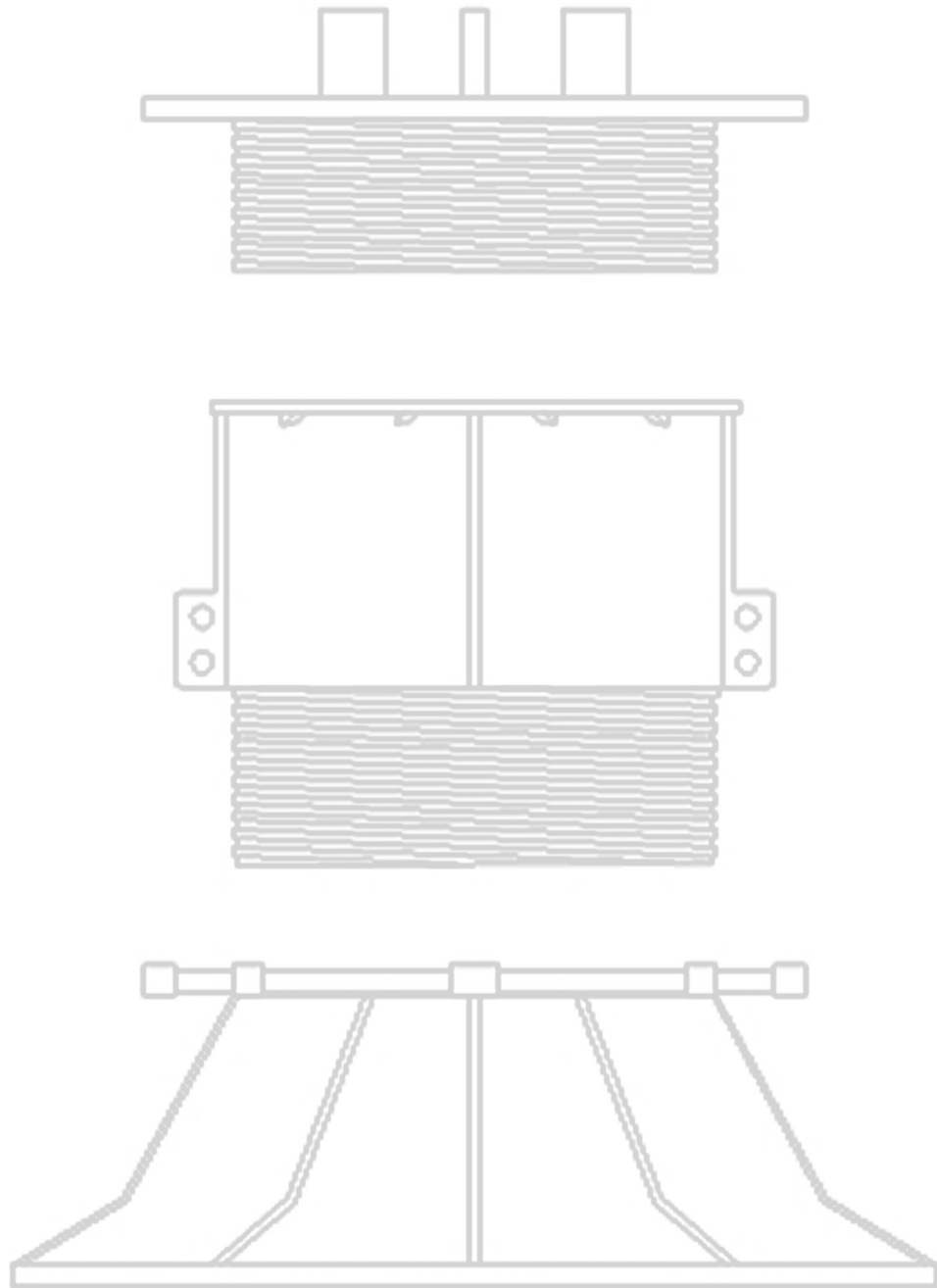

E - Technical Specifications

General Features

Adjustable Height: 35 - 1090 mm variable elevation
 Loading Capacity: Central loading min. 1000kg/pedestal
 Material: Polypropylene (PP)
 UV Resistance
 Elevation adjustment: %0 -15 (multithreaded %2-%3 elevation wedge)
 Recycling: %100
 Low temperature reaction: -20°C
 Sound insulation: 25 DB
 Fire reaction: Class E
 Easy installation, demontation and portability
 Equal charge distribution: Diameter 206 mm (333cm²) bottom base
 Diameter 153 mm (183cm²) top base
 Diameter 121 mm additional lifting bases
 Fast Drainage (open joint system)
 Design elasticity (30-45-60-90-120-150 degree angled corner joint with demounted joint strips)
 Service capacity for installations
 Service life: Thermoplastic material

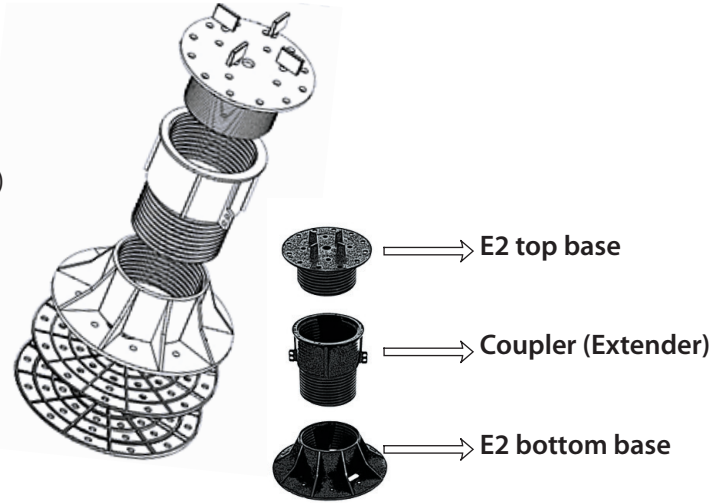

• **Support E** - It is used for Natural, Granule and Composite Stones etc. and Thermowood, Composite and Natural Woods etc.

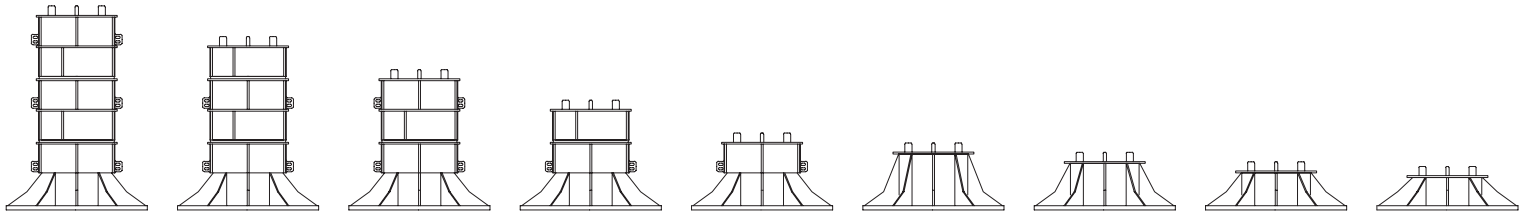







Code	Adjustments of Height
E0	35 - 50 mm
E1	50 - 75 mm
E2	75 - 115 mm
E3	110 - 185 mm
E4	140 - 220 mm
E5	205 - 330 mm
E6	270 - 440 mm
E7	340 - 550 mm
E8	405 - 660 mm
E9	470 - 760 mm
E10	540 - 870 mm
E11	605 - 980 mm
E12	670 - 1090 mm

Amount of Use	
Size of Tile	m ² / Unit
40 x 40 cm	6,25
50 x 50 cm	4
40 x 60 cm	4,17
60 x 60 cm	2,78

Accessories	
Code	Description
EC	Coupler (66-110 mm)
EU	Fixed carcass holder (4 mm)
EUWF	Moving carcass holder (h=18 mm)
EUWFH	Moving carcass holder (h=38 mm)
SH10	Adjusting shim (1,3 mm)
SH20	Adjusting shim (2 mm)
SH50	Adjusting shim (5 mm)
SC20	Slope Corrector (2%)
SC30	Slope Corrector (3%)
LC	Lock (4 mm)
JP	Joint Plus
J20	Joint (2 mm)
J30	Joint (3 mm)
J45	Joint (4,5 mm)
J47	Joint (4,7 mm)
J60	Joint (6 mm)
J80	Joint (8 mm)
T	Clips

Products

E0 35 - 50 mm 	E1 50 - 75 mm 	E2 75 - 115 mm 	E3 110 - 185 mm 	E4 140 - 220 mm 
E5 205 - 330 mm 	E6 270 - 440 mm 	E7 340 - 550 mm 	E8 405 - 660 mm 	E9 470 - 760 mm 
E10 540 - 870 mm 	E11 605 - 980 mm 	E12 670 - 1090 mm 		

Accessories

EUWF-EUWFH  MOVING CARCASS HOLDER	SH10  ADJUSTING SHIM (1,3 mm)	SH20  ADJUSTING SHIM (2 mm)	SH50  ADJUSTING SHIM (5 mm)	T  CLIPS	JP  JOINT PLUS
EC  COUPLER	J20-30-45-47-60-80  JOINT	SC20  SLOPE CORRECTOR (% 2)	SC30  SLOPE CORRECTOR (% 3)	LC  LOCK	EU  FIXED CARCASS HOLDER

E - Packing List

E-0

(35-50 mm)



Weight (gr) / Item
290

Items / Carton
90

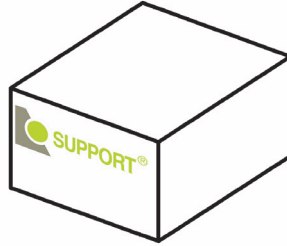

Dimension (cm) / Box : 63x63x40
Weight (kg) / Box : 1,66
Gross weight (kg)/Box : 27,76

Items (Box)
/ Pallet
16

Items / Pallet
1440

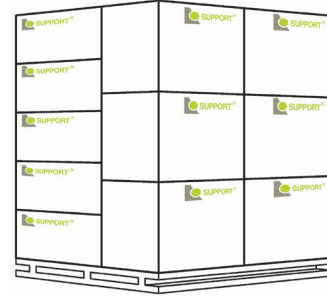

Net weight (kg) / Pallet : 417,60
Gross weight (kg) / Pallet : 464,16
Dimension (cm) / Pallet : 110x130x15 cm

E-1

(50-75 mm)



Weight (gr) / Item
350

Items / Carton
63



Dimension (cm) / Box : 63x63x40
Weight (kg) / Box : 1,66
Gross weight (kg)/Box : 23,71

Items (Box)
/ Pallet
16

Items / Pallet
1008

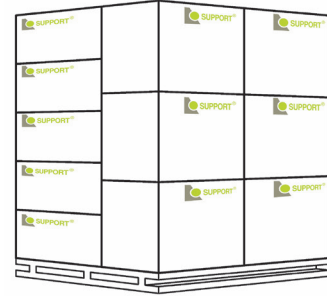

Net weight (kg) / Pallet : 352,80
Gross weight (kg) / Pallet : 399,36
Dimension (cm) / Pallet : 110x130x15 cm

E-2

(75-115 mm)



Weight (gr) / Item
415

Items / Carton
45



Dimension (cm) / Box : 63x63x40
Weight (kg) / Box : 1,66
Gross weight (kg)/Box : 20,34

Items (Box)
/ Pallet
16

Items / Pallet
720



Net weight (kg) / Pallet : 298,80
Gross weight (kg) / Pallet : 345,36
Dimension (cm) / Pallet : 110x130x15 cm

E - Packing List

E-3

(110-185 mm)



Weight (gr) / Item
530

Items / Carton
36

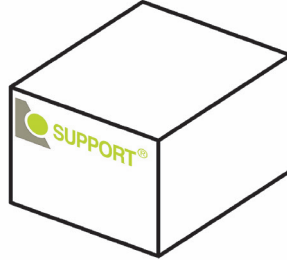

Dimension (cm) / Box : 63x63x46,5
Weight (kg) / Box : 1,75
Gross weight (kg)/Box : 20,83

Items (Box) / Pallet
14

Items / Pallet
504

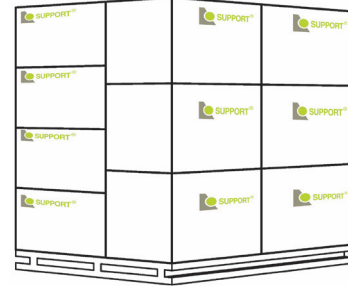

Net weight (kg) / Pallet : 267,12
Gross weight (kg) / Pallet : 311,62
Dimension (cm) / Pallet : 110x130x15 cm

COUPLER

(66-110 mm)



Weight (gr) / Item
230

Items / Carton
125



Dimension (cm) / Box : 63x63x40
Weight (kg) / Box : 1,4
Gross weight (kg)/Box : 30,15

Items (Box) / Pallet
16

Items / Pallet
2000



Net weight (kg) / Pallet : 460,00
Gross weight (kg) / Pallet : 502,40
Dimension (cm) / Pallet : 110x130x15 cm

E4

(140-220 mm)



E2 Top base

1 Coupler

E2 Bottom base



Carton E2

Carton Coupler



E - Packing List

E-5

(205-330 mm)

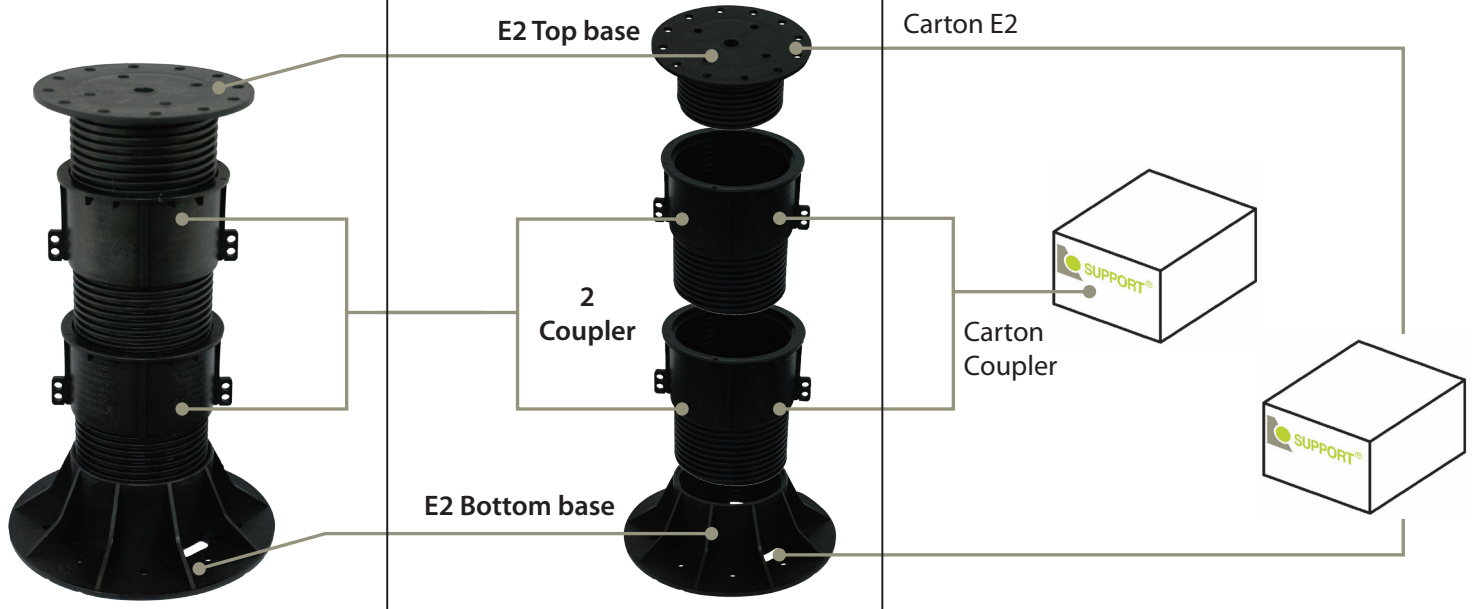

E-6

(270-440 mm)

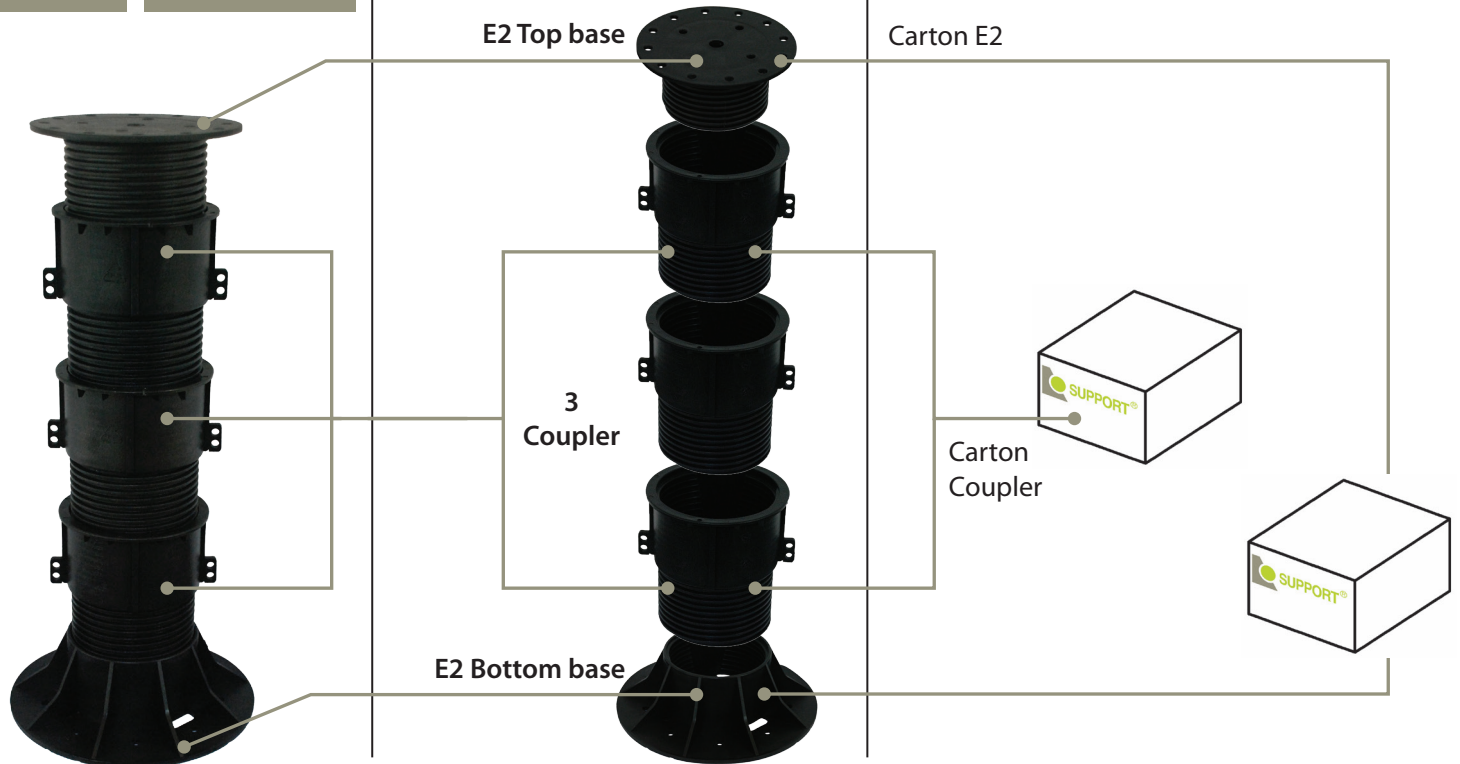

E - Packing List

E-7

(340-550 mm)

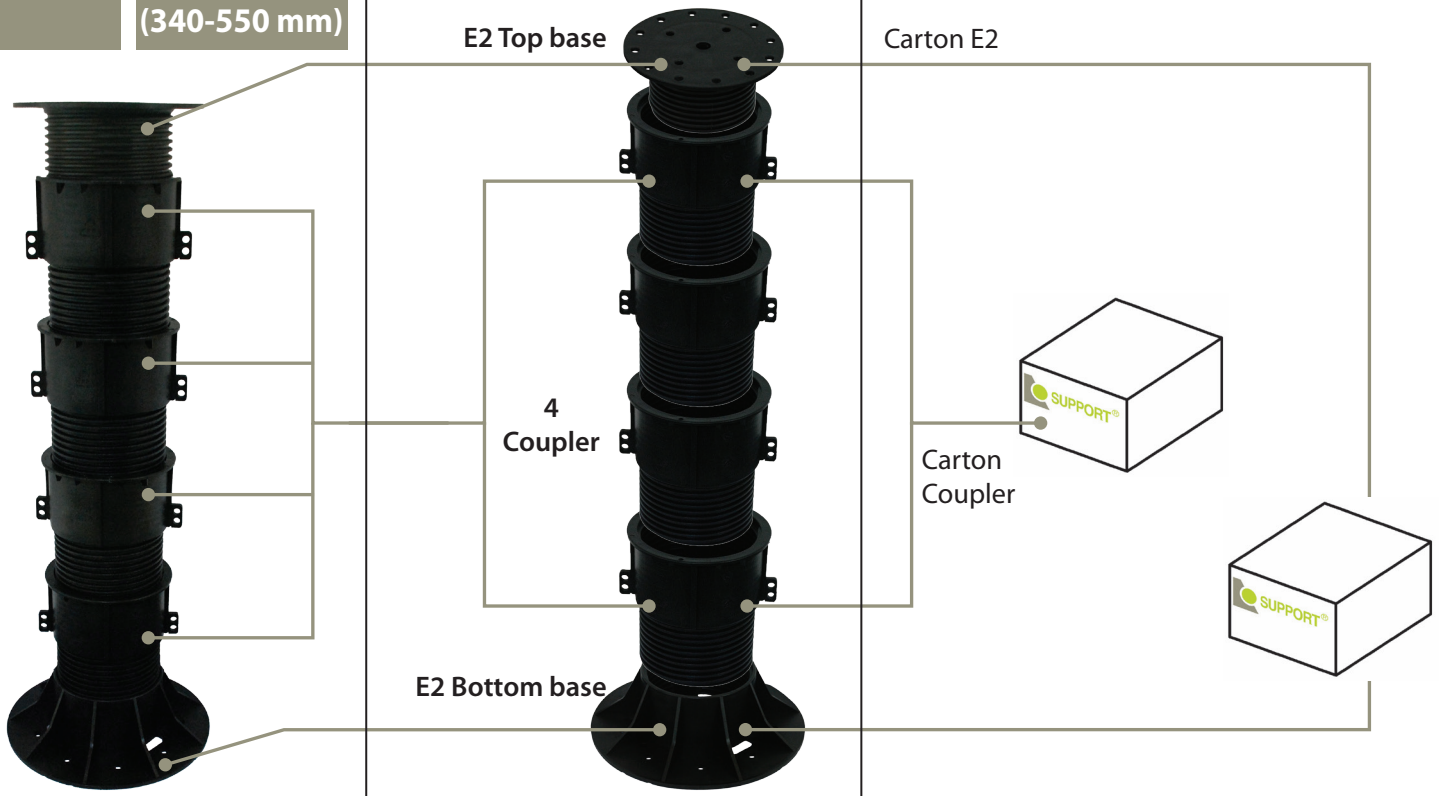

E-8

(405-660 mm)

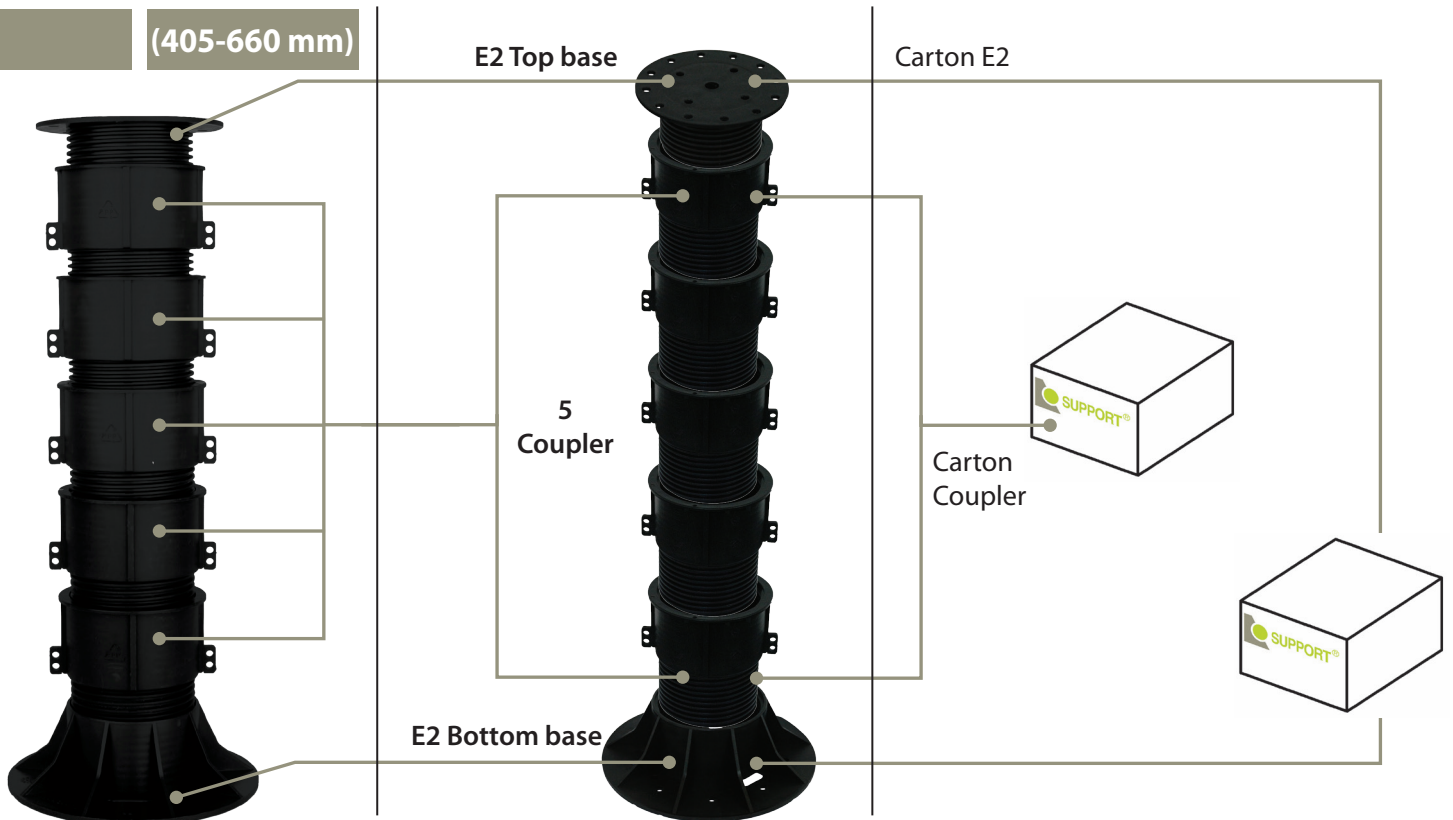

E - Packing List

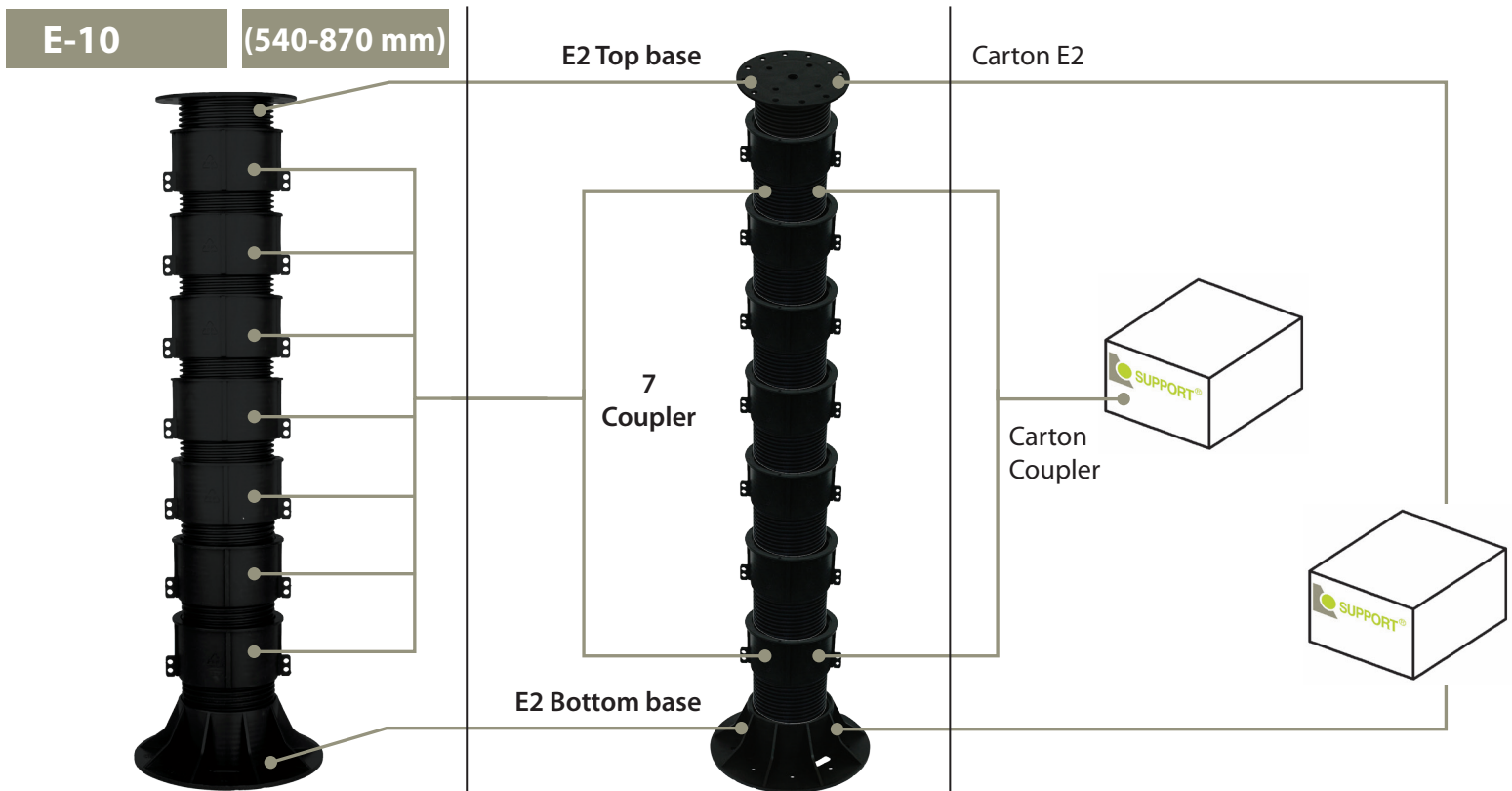
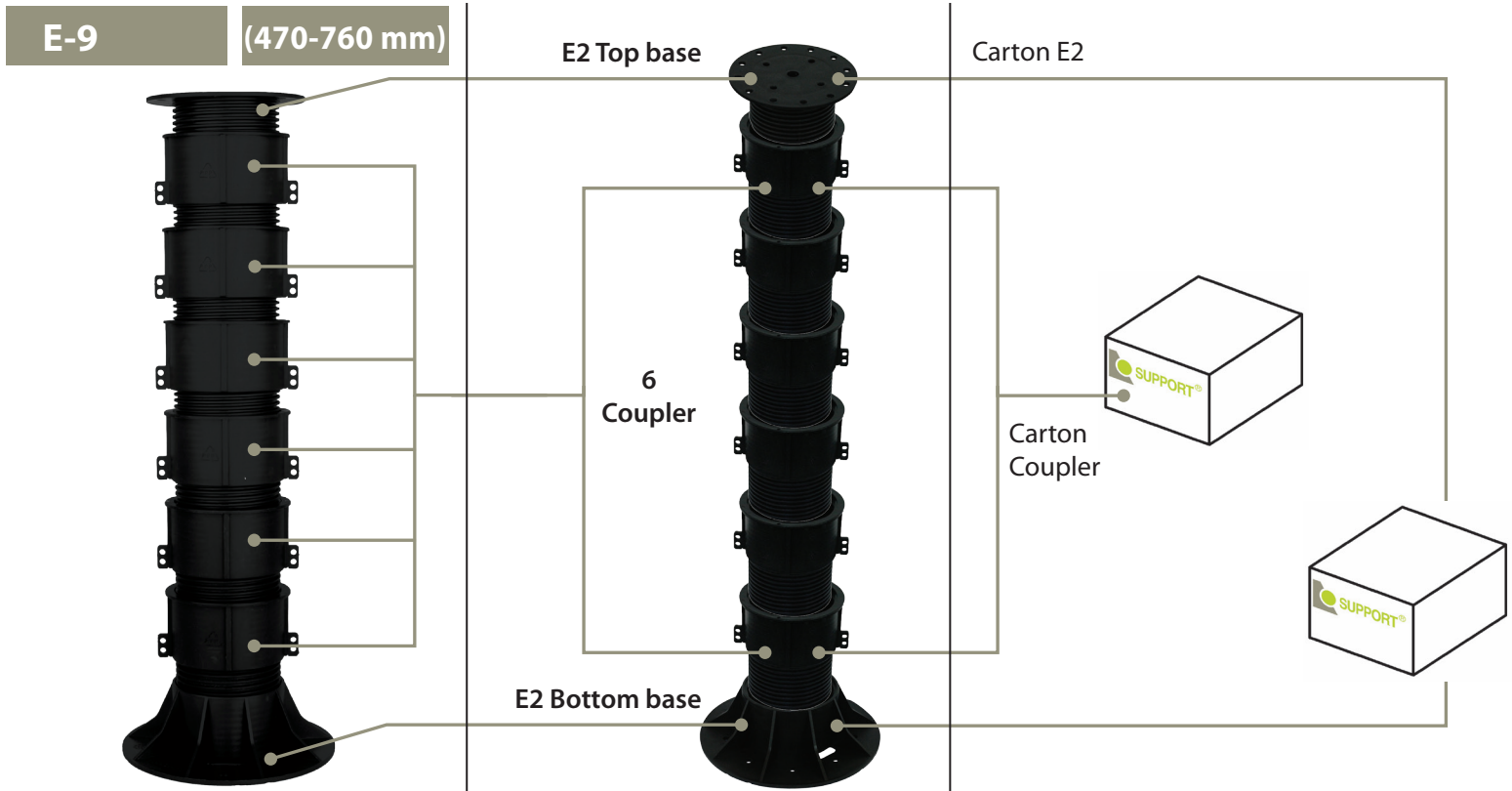

E - Packing List

E-11

(605-980 mm)

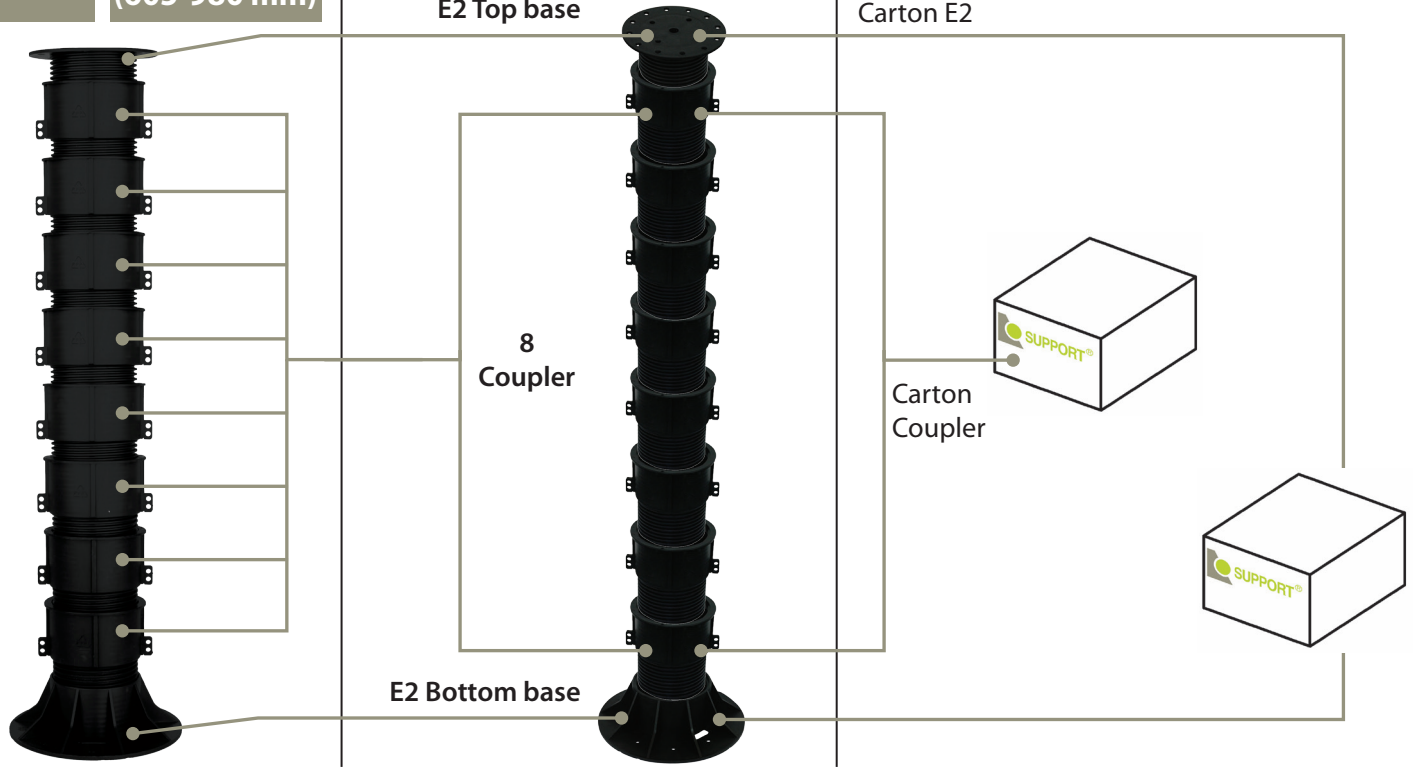

E-12

(670-1090 mm)

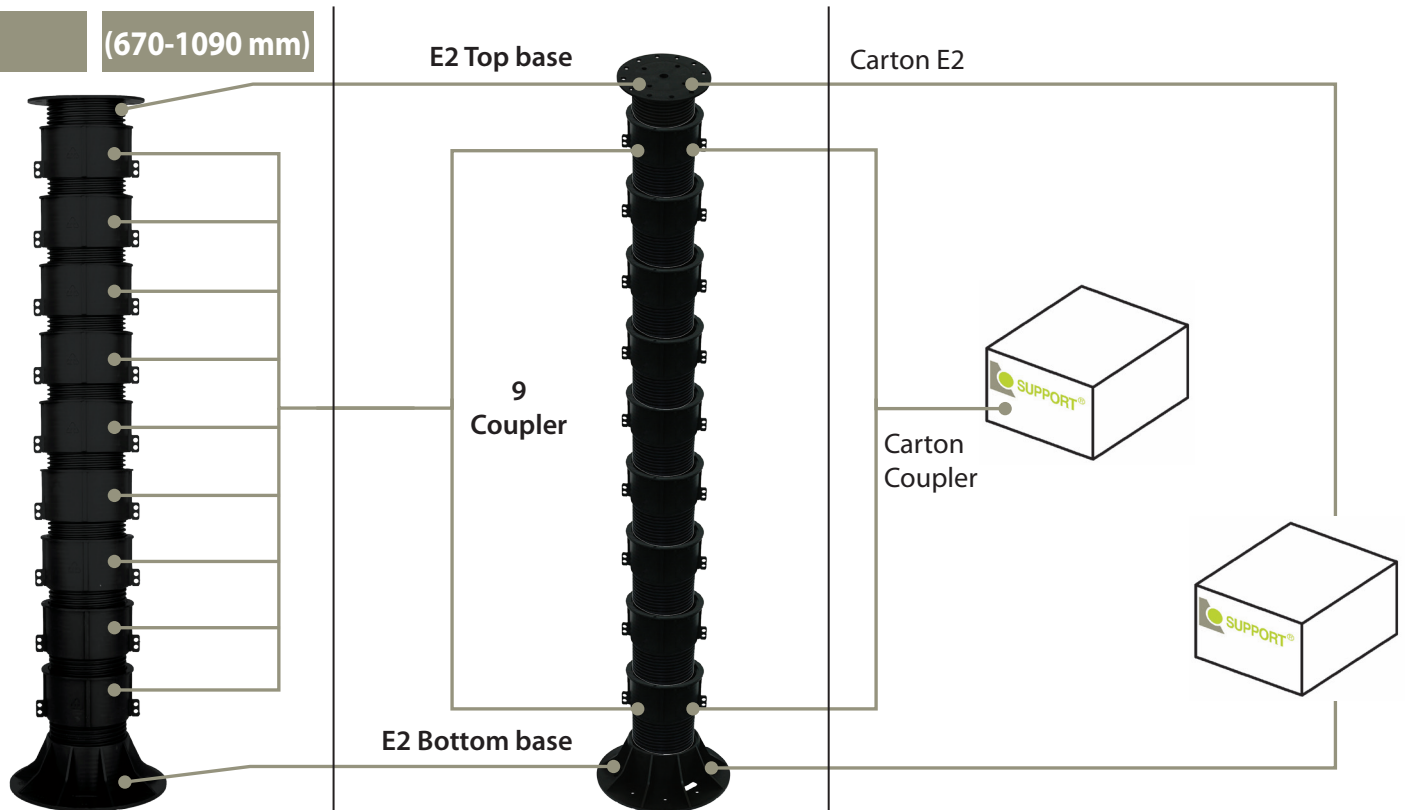

E - Accessories Packing List

EU

Fixed carcass holder

Thickness

4 mm



Weight (gr) / Item
72

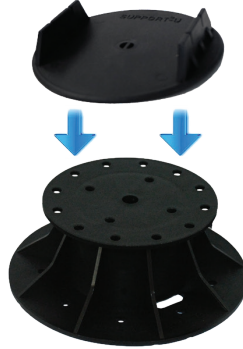

Item / Carton

125



Dimension (cm) / Box: : 21x63x40
Weight (kg) / Box : 0,57
Gross weight (kg)/Box : 9,57
Net weight (kg) : 9,00

EUWF

Moving carcass holder

Thickness

h=18 mm



Weight (gr) / Item
10

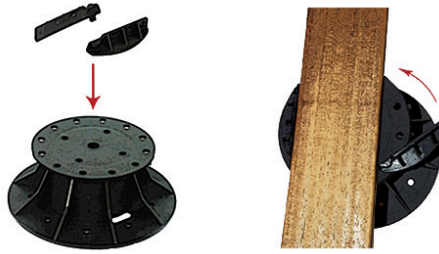

Item / Carton

500



Dimension (cm) / Box: : 25x25x25
Weight (kg) / Box : 0,17
Gross weight (kg)/Box : 5,17
Net weight (kg) : 5

EUWFH

Moving carcass holder

Thickness

h=38 mm



Weight (gr) / Item
15

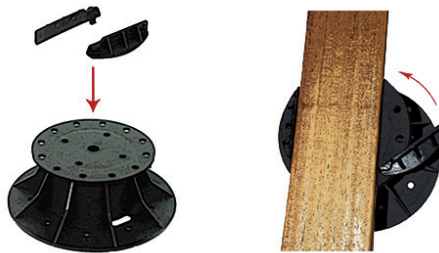

Item / Carton

270

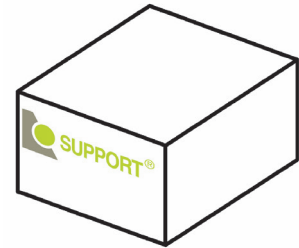

Dimension (cm) / Box: : 25x25x25
Weight (kg) / Box : 0,17
Gross weight (kg)/Box : 4,22
Net weight (kg) : 4,05

E - Accessories Packing List

SH10

Adjusting shim

Thickness
1,3 mm

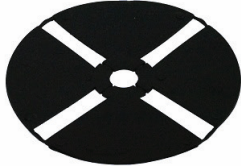

Weight (gr) / Item
12

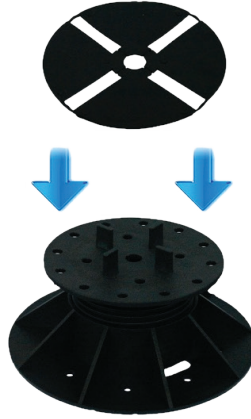

Item / Carton

600



Dimension (cm) / Box: : 22x22x22
Weight (kg) / Box : 0,12
Gross weight (kg)/Box : 7,32
Net weight (kg) : 7,20

SH20

Adjusting shim

Thickness
2 mm



Weight (gr) / Item
20

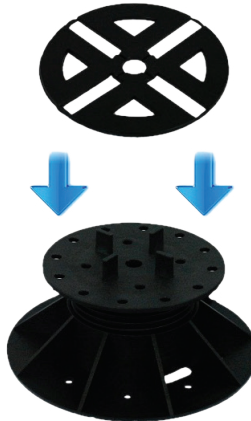

Item / Carton

400

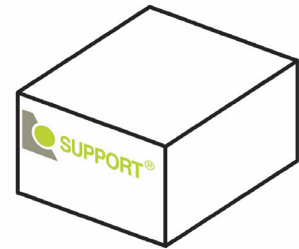

Dimension (cm) / Box: : 22x22x22
Weight (kg) / Box : 0,12
Gross weight (kg)/Box : 8,12
Net weight (kg) : 8,00

SH50

Adjusting shim

Thickness
5 mm



Weight (gr) / Item
40

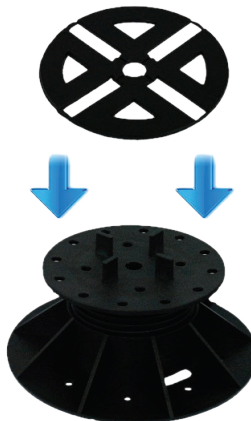

Item / Carton

170

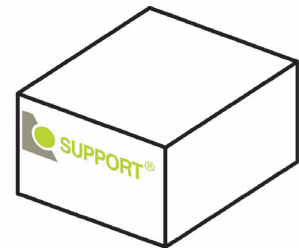

Dimension (cm) / Box: : 22x22x22
Weight (kg) / Box : 0,12
Gross weight (kg)/Box : 6,92
Net weight (kg) : 6,80

E - Accessories Packing List

SC20
Slope Corrector

Slope
2%



Weight (gr) / Item
84



Item / Carton
45



Dimension (cm) / Box: : 22x22x22
Weight (kg) / Box: : 0,12
Gross weight (kg)/Box: : 3,9
Net weight (kg): : 3,78

SC30
Slope Corrector

Slope
3%



Weight (gr) / Item
96

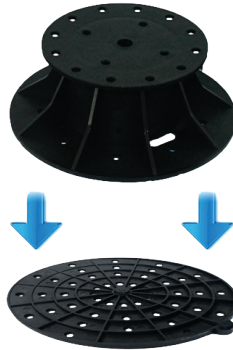

Item / Carton
35



Dimension (cm) / Box: : 22x22x22
Weight (kg) / Box: : 0,12
Gross weight (kg)/Box: : 3,48
Net weight (kg): : 3,36

LC
Lock

Thickness
4 mm



Weight (gr) / Item
42



Item / Carton
200



Dimension (cm) / Box: : 21x63x40
Weight (kg) / Box: : 0,57
Gross weight (kg)/Box: : 8,97
Net weight (kg): : 8,40

E - Accessories Packing List

JP Joint Plus



Weight (gr) / Item
12

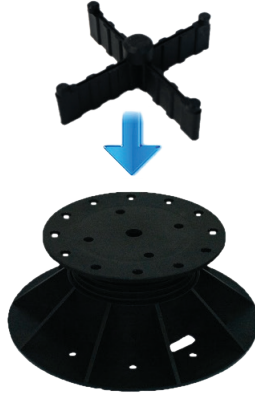

Item / Carton
750

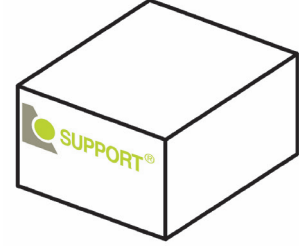

Dimension (cm) / Box: : 21x63x40
Weight (kg) / Box : 0,57
Gross weight (kg)/Box : 9,57
Net weight (kg) : 9,00

Joint



Code	Thickness	Weight (gr) / Box	Items / Carton	Gross weight (kg) / Box	Net Weight (kg)
J20	2 mm	0,85	6000	5,27	5,10
J30	3 mm	1,2	5000	6,17	6,00
J45	4,5 mm	1,3	4000	5,37	5,20
J47	4,7 mm	2,5	2000	5,17	5,00
J60	6 mm	3,4	2000	6,97	6,80
J80	8 mm	4,3	1500	6,62	6,45

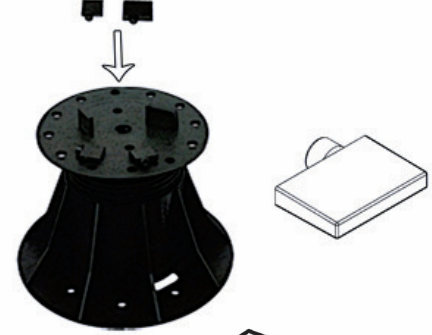

Dimension (cm) / Box: : 25x25x25
Weight (kg) / Box : 0,17

T Clips



Weight (gr) / Item
5

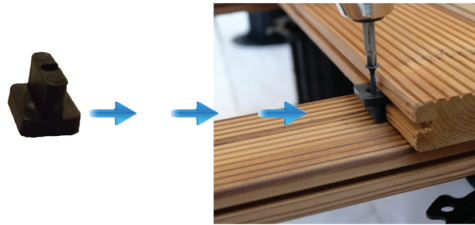

Item / Carton
1900



Dimension (cm) / Box: : 25x25x25
Weight (kg) / Box : 0,17
Gross weight (kg)/Box : 9,67
Net weight (kg) : 9,50

ST İthalat İhracat Ltd. Şti

Address: Yenibosna Doğu Sanayi Sitesi
2/11 34180 Bahçelievler - İstanbul / Turkey

T. +90 (212) 452 20 60
F. +90 (212) 452 20 27

E-mail: export@supportsystem.com
Web: www.supportpedestal.com

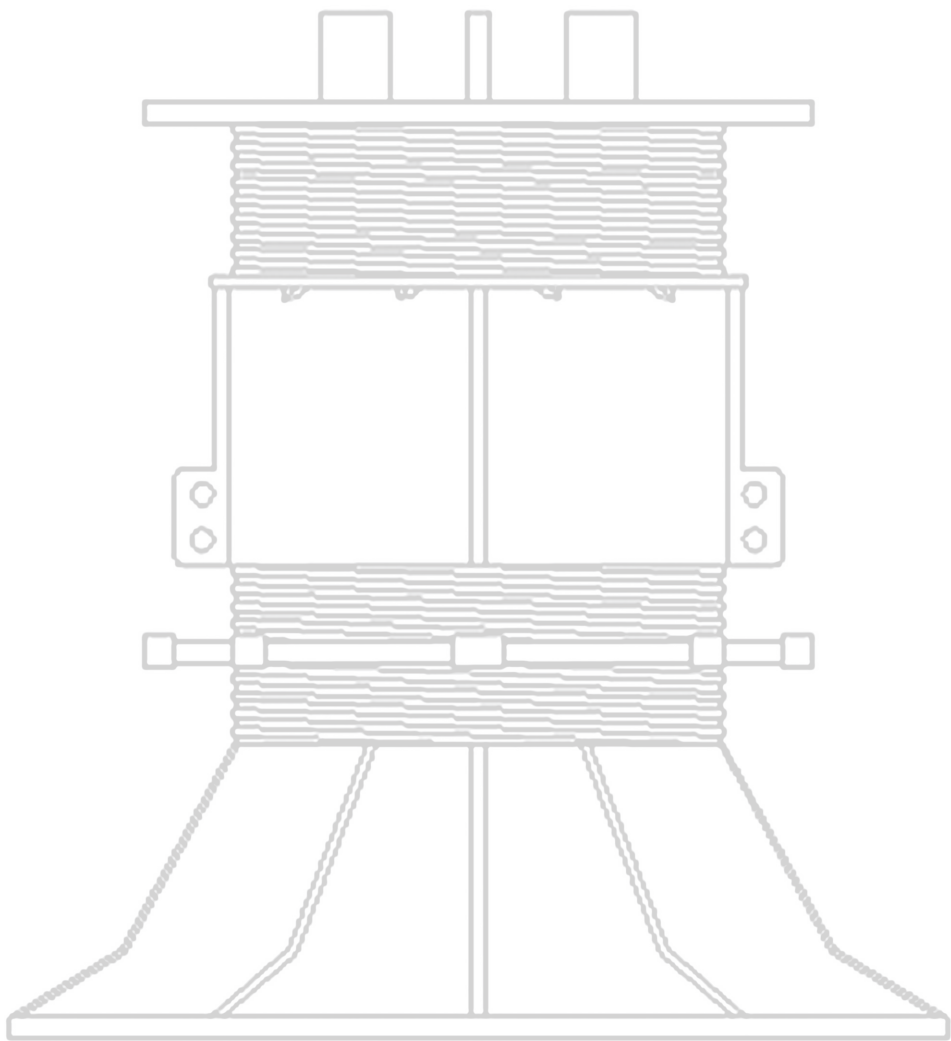

References

Telecom City
Russia

Terrace Projects
Russia

Swimming Pool
Construction Project
Dubai

National Gymnastic
Arena / Azerbaijan

Port Baku Residence
Azerbaijan

Promenada Mall
Romania

Subway Station Project Medina
Saudi Arabia

Haydar Aliyev
Cultural Center / Azerbaijan

225 Liberty Street
Project / USA

Gambit - Dry - Deck Fountain
Project / Russia

Next Level Residence
Ankara

Harbiye Congress Center
Istanbul

Zorlu Center
Istanbul

Exen Istanbul- Residence
Uskudar / Istanbul

Akbati Mall
Bahçeşehir / Istanbul

• Naval Museum / Istanbul • Harbiye Congress Center / Istanbul • Ataşehir Municipal Building / Istanbul • Boğaziçi University / Istanbul • HalkBank Head Office / Istanbul • Turkish Contractors Association Head Office / Ankara • Akasya Acıbadem Mall / Istanbul • Residence "Rönesans Biz" / Istanbul • Bursa City Square / Bursa • Erasta Mall / Antalya • Park Bosphorus Hotel / Istanbul • Esas Aeropark (Pegasus Airlines) / Istanbul • Bomonti Residence / Istanbul • "Mercedes Benz" Factory / Istanbul • TED College / Ankara • Vicem Summer Villas / Bodrum • Doğu Holding Head Office / Istanbul • Acıbadem University / Istanbul • Kemer Golf Country Club / Istanbul • Sapphire Mall - Residence / Istanbul • Kapadokya Arinna Hotel / Nevşehir • Centre Commercial "Kayseri Forum" / Kayseri • Kristal Kule Residence / Istanbul • Le Méridien Hotel / Istanbul • "Buyaka Mall" / Istanbul • Ist-west Residence / Istanbul • Ottomare Hotel / Istanbul • Torun Towers Residence / Istanbul • Bosphorus City Residence / Istanbul • American Embassy / Istanbul • Sakıp Sabancı Museum / Istanbul • Newada Residence / Istanbul • Starbucks Buyaka Mall / Istanbul • Papyrus Plaza / Istanbul • Ataköy Marina / Istanbul • Maçka Hotel / Istanbul • Tepe Prime Residence / Ankara • Rings İstanbul Residence / Istanbul • İstanbul Technical University "Ufuk Güldemir" Museum / Istanbul • Mowenpick Hotel / Ankara • Sundance Hotel / Bodrum • Divan Hotel / Istanbul • Galatasaray Association / Istanbul • Revan Pera Restaurant / Istanbul • Philip Morris Head Office / Izmir • RBS Bank / Istanbul • Bahçeşehir University / Istanbul • Eczacıbaşı Museum / Istanbul • Garanti Bank - Head Office / Istanbul • Kültür University / Istanbul • Lykya Golf Hotel / Antalya • Riverside Hotel / Moscow Russia • Mezzanine Hotel / Romania

SUPPORT[®]

www.supportpedestal.com

e-mail: export@supportsystem.com

T.+90 212 452 20 60 F.+90 212 452 20 27

ST İthalat İhracat Ltd. Şti.

Yenibosna Doğu Sanayi Sitesi 2/11 34180 Bahçelievler - İstanbul / Turkey

